

FLAT ROOF SKYLIGHTS – FCM/VCM/VCS (“Curb Mounted” Skylights)

Curb detail – suggestion only. (flashing is not supplied with the flat roof skylights)

The diagram describes a suggested method of fixing the FCM/VCM/VCS on a curb flashing. As such it is intended to be used **as a guide only**. Any roof flashing, waterproofing or insulation is to be supplied by the installer/roofer and must be suitable for the type of roofing material.

The installation of the flashing onto the roof remains the responsibility of the installer.

This diagram does not apply to any internal and/or external guarantees issued.

Diagram shown is the FCM.

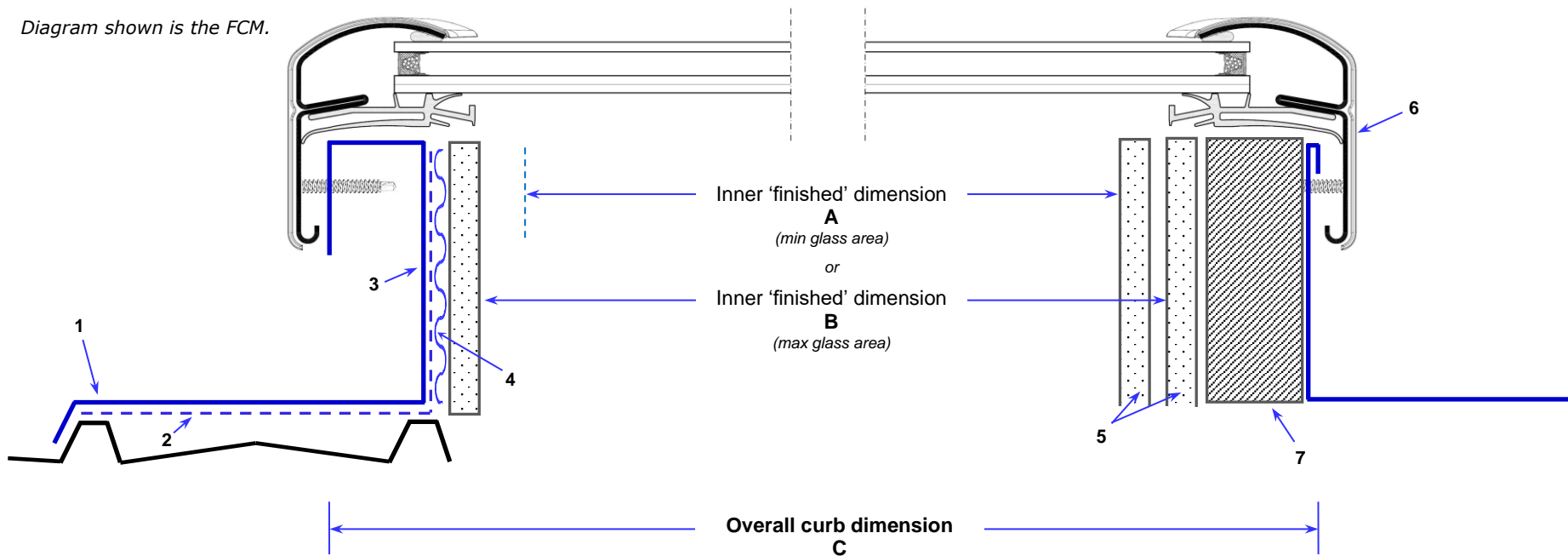

1	Purpose built flashing / curb	Flashing made by installer. Must have 'turnback' for water splashback. Must cover min 2 ribs of roofing (or as per building regulations)
2	Underlay / thermal blanket	Waterproof / thermal barrier – ideally wrapped around the entire curb before flashing is installed.
3	Curb / Upstand	Minimum recommended height 100mm. Must comply with local building regulations. 35mm-50mm wide.
4	Insulation	Optional. Supplied by installer.
5	Internal Lining (eg: plasterboard)	Position of lining will determine the overall exposed glass area. (can encroach on glass area up to max 15mm each side)
6	Skylight frame	Fits over and secures to curb.
7	Timber Curb	Offers more secure installation with better thermal properties. Timber curb must be used in cyclonic regions.

FCM / VCM / VCS		
Model	Inner finished dimension 'A' – minimum	
1430	335	745
2222 *	540	540
2230	540	745
2234 *	540	845
2246 *	540	1150
2270 ^	540	1760
3030 *	745	745
3046 *	745	1150
3055	745	1380
3434	845	845
3446	845	1150
4622 *	1150	540
4646 *	1150	1150
	Inner finished dimension 'B' – maximum	
1430	368	775
2222 *	572	572
2230	572	775
2234 *	572	876
2246 *	572	1181
2270 ^	572	1792
3030 *	775	775
3046 *	775	1181
3055	775	1410
3434	876	876
3446	876	1181
4622 *	1181	572
4646 *	1181	1181
	MAXIMUM Curb dimension 'C'	
1430	460	870
2222 *	665	665
2230	665	870
2234 *	665	970
2246 *	665	1275
2270 ^	665	1885
3030 *	870	870
3046 *	870	1275
3055	870	1505
3434	970	970
3446	970	1275
4622 *	1275	665
4646 *	1275	1275

FCM

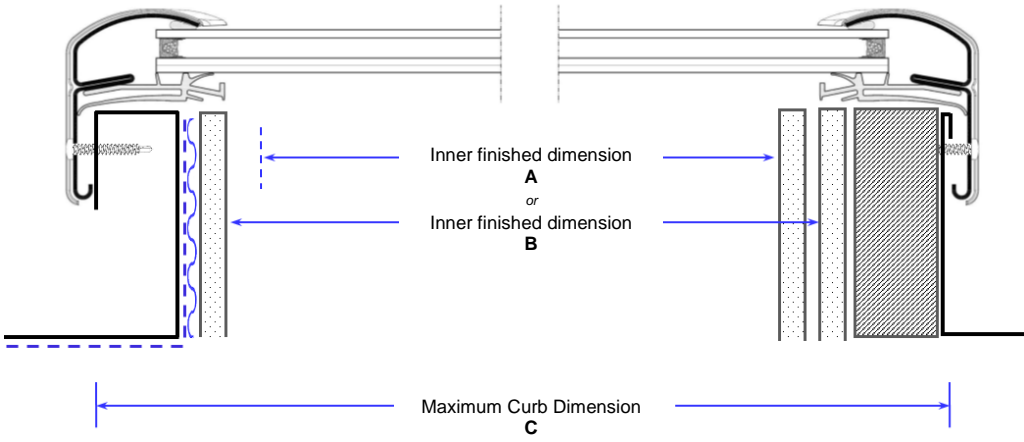

VCM / VCS

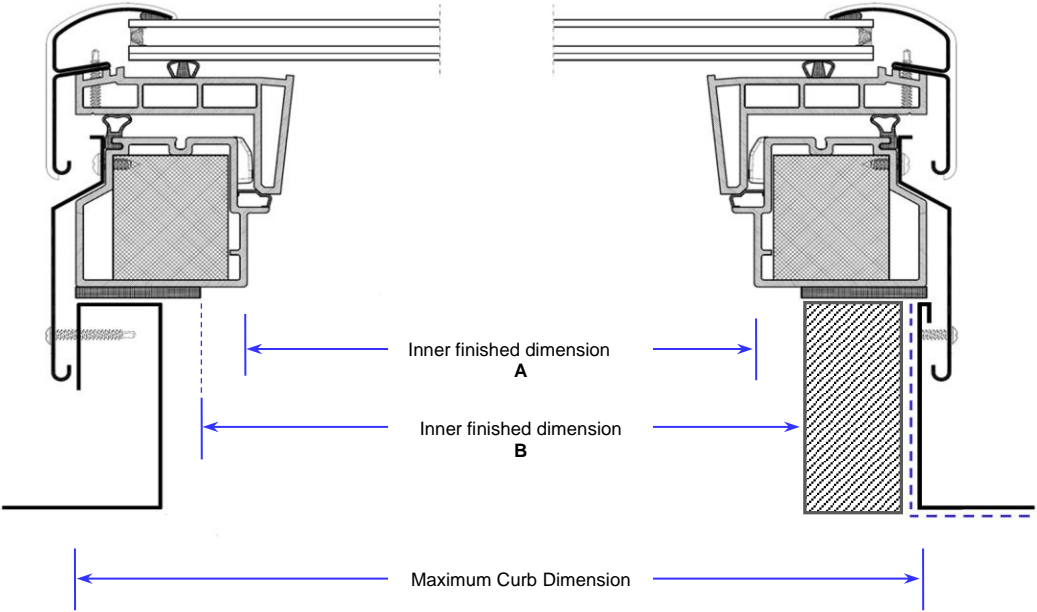

All dimensions in mm
 ^ FCM 2270 not recommended for landscape orientation.
 * VCM/VCS cannot be installed in landscape orientation

BUILDING THE CURB / CURB THICKNESS

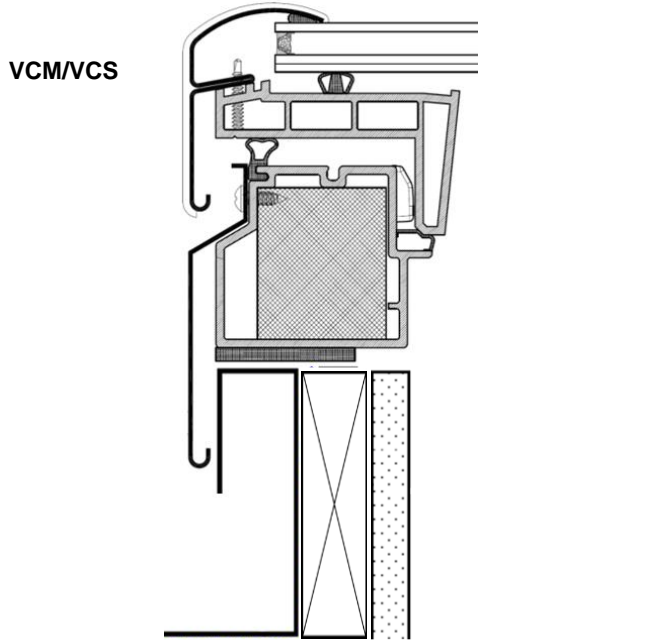

Outside Curb Dimension → | A | B | C | ← Minimum 'finished' dimension

- A - Flashing
- B - Timber
- C - Lining (plasterboard, etc)

Curb thickness: Comprises Flashing+Curb+Lining

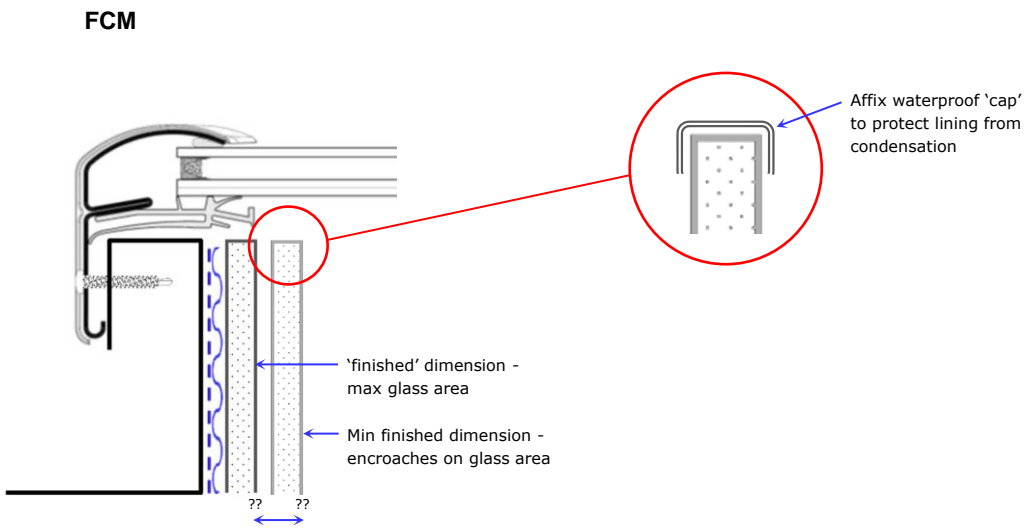

FCM: Thickness of finished curb will determine if lining encroaches on glass area

(Timber curbs are mandatory for cyclonic regions)

* VCM/VCS – Cannot be installed in landscape orientation

MULTIPLE SKYLIGHTS

Overall Curb Dimension and Inside Purlin dimension is dependent on the following:

- Total number of skylights
- Space between skylights (recommended minimum = 100mm)

* Inside purlin dimension: can be single large opening if desired – however inner supports are still needed for the individual skylights. (see diagram next page)

(See picture page 10)

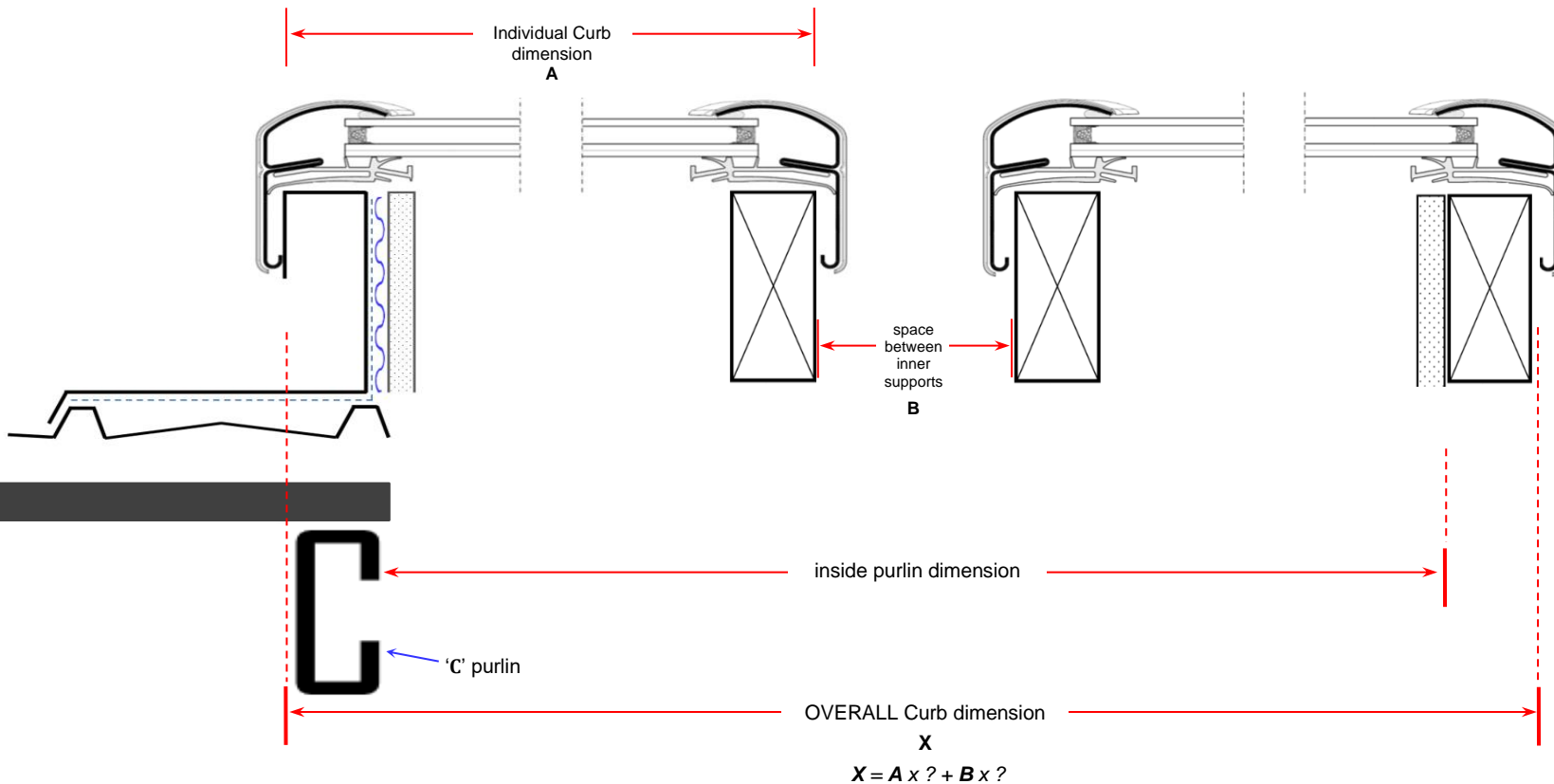

* VCM/VCS – Cannot be installed in landscape orientation

INSULATION

Whenever you install a Flat Roof Skylight, VELUX recommends you insulate the base and/or flashing for maximum thermal efficiency. (VELUX does not supply insulation)

With an appropriate insulation and lining, a skylight can achieve very high thermal efficiency.

The addition of a timber curb timer will increase the overall thermal rating of the installation. However, if you are using a timber curb, insulation may not be necessary. Consult with relevant authorities for thermal efficiency requirements.

VELUX always recommends using an underlay with any type of flashing.

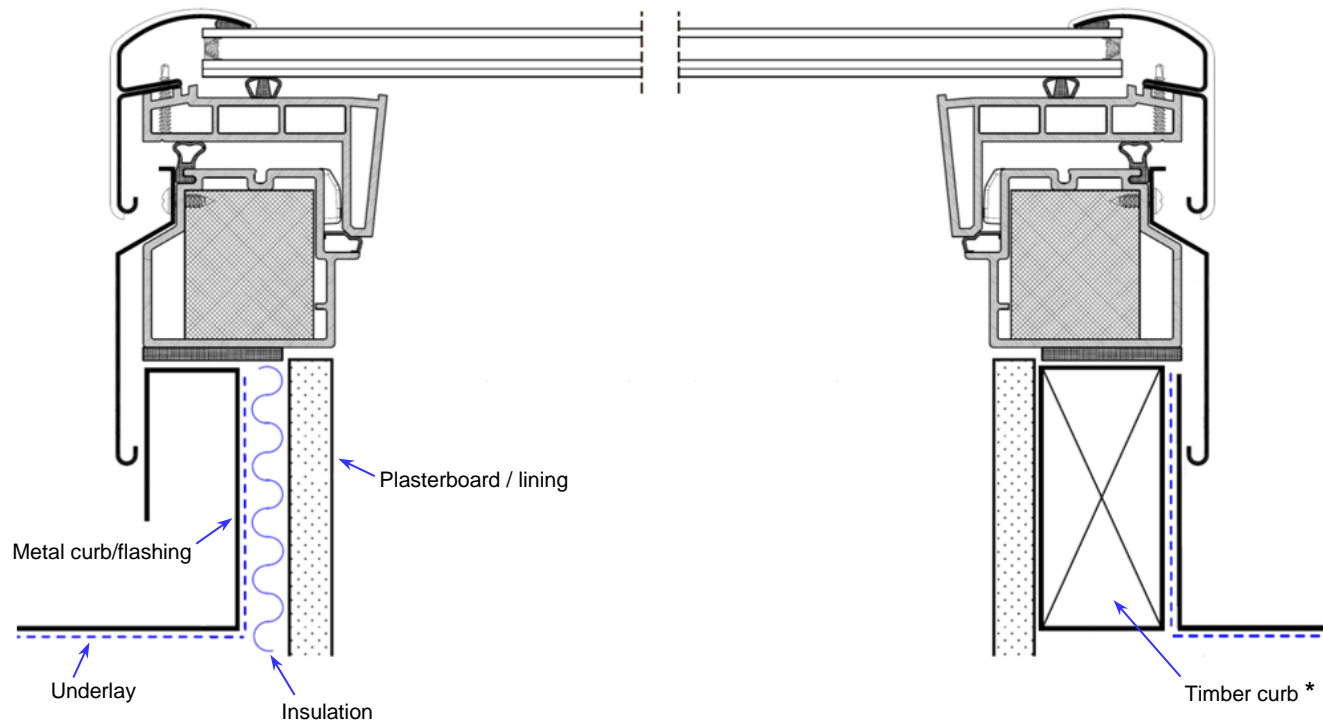

* Timber curbs are mandatory for cyclonic regions

FLASHING

FLASHING FOR CURB

The flashing is typically made in sections and assembled around the timber curb - or as the curb if timber is not used.

Water diverters are recommended. Flashing must always overlap from the *top down*: side pieces overlap the bottom section; top section overlaps the sides.

All flashings must conform to relevant NCC or State/Territory requirements.

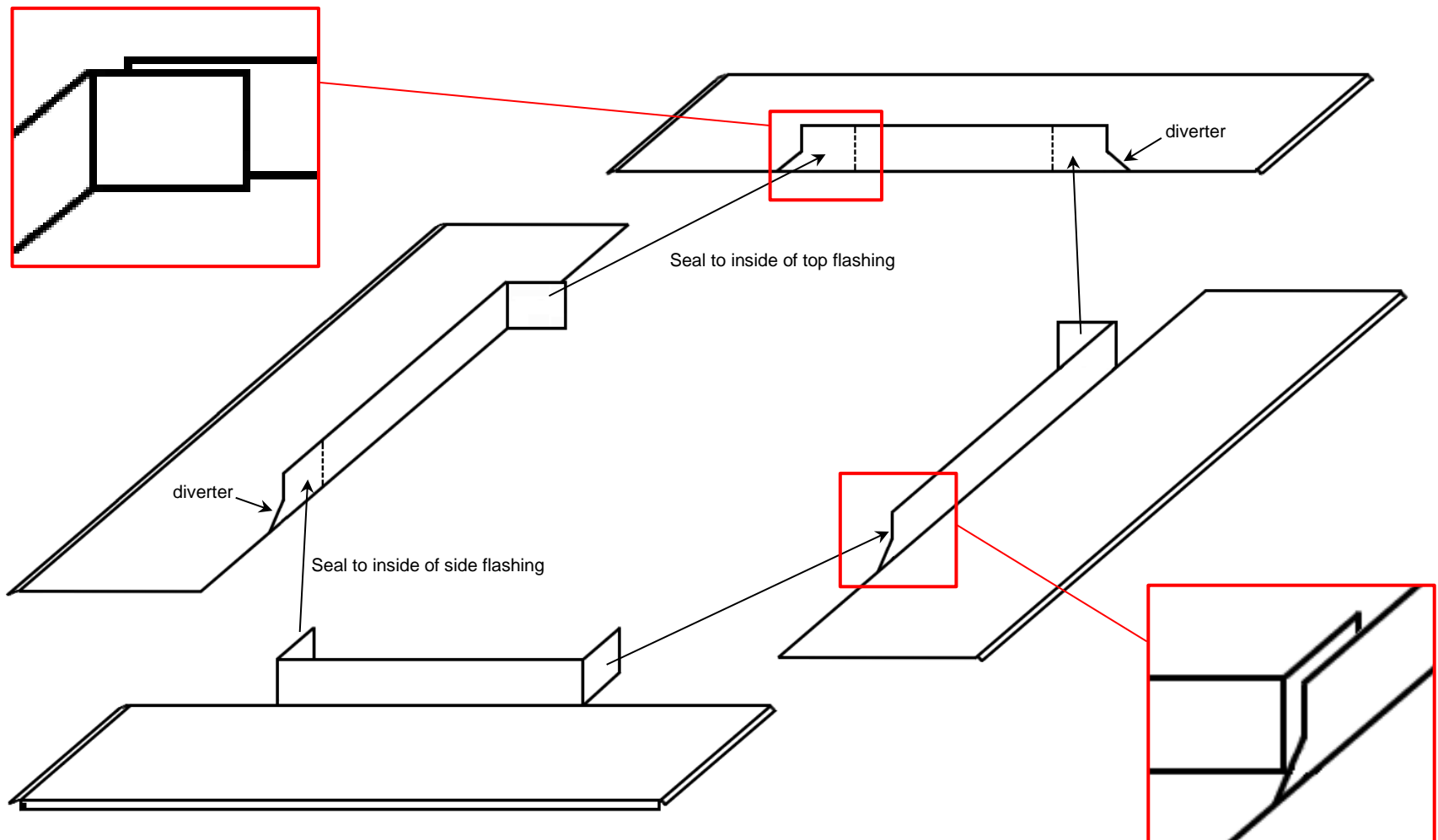

BASE – assembled

(See pictures page 9)

The top tray of the base can be installed:

- Above the roofing - preferably all the way to the ridge capping (see diagram last page)
- Under the roofing. The top of the base can be made as a flat panel to go under metal roofing. (see diagram last page)

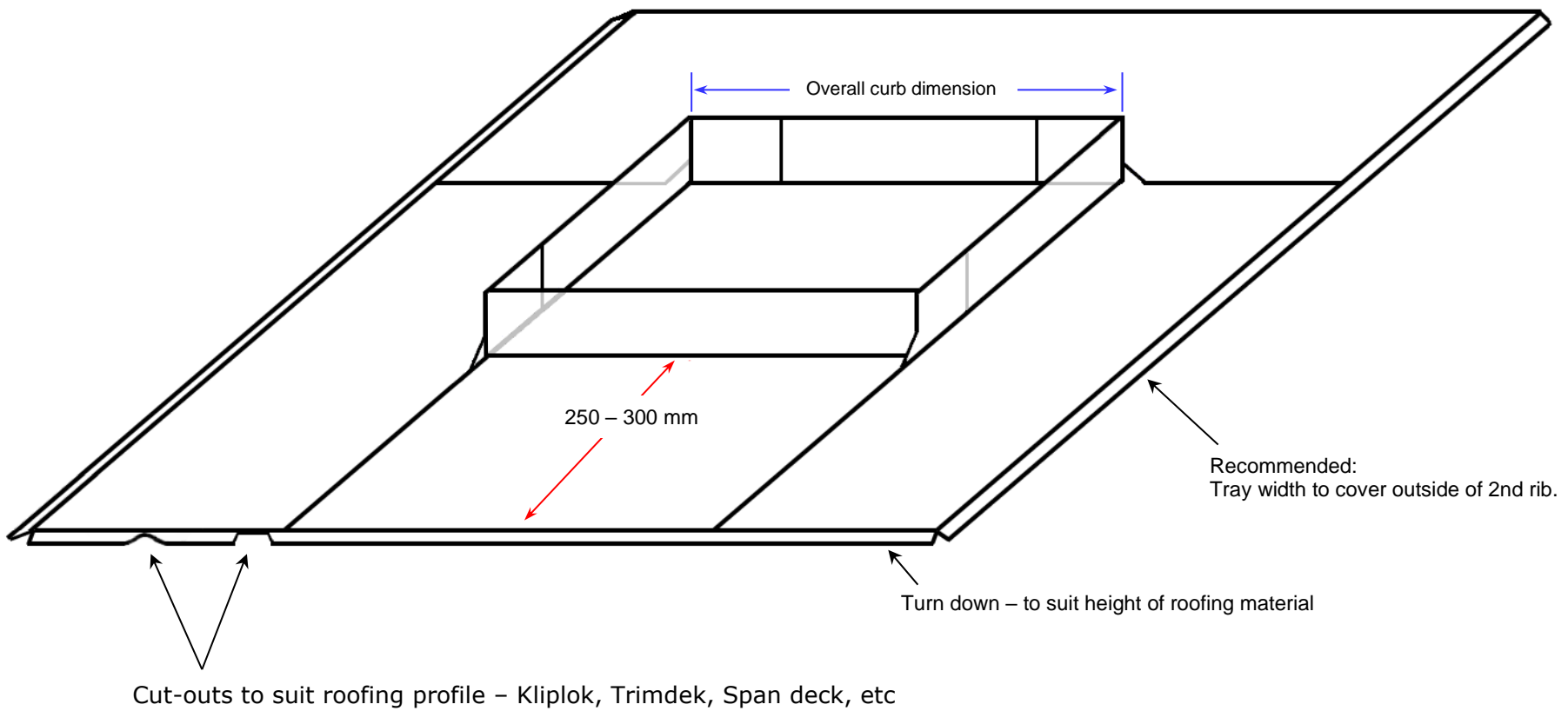

Alternative design

An alternative design of the base utilises a “turndown” to deflect water splashback.

Whether the upstand is timber or metal, a splashback turndown on the flashing is recommended.

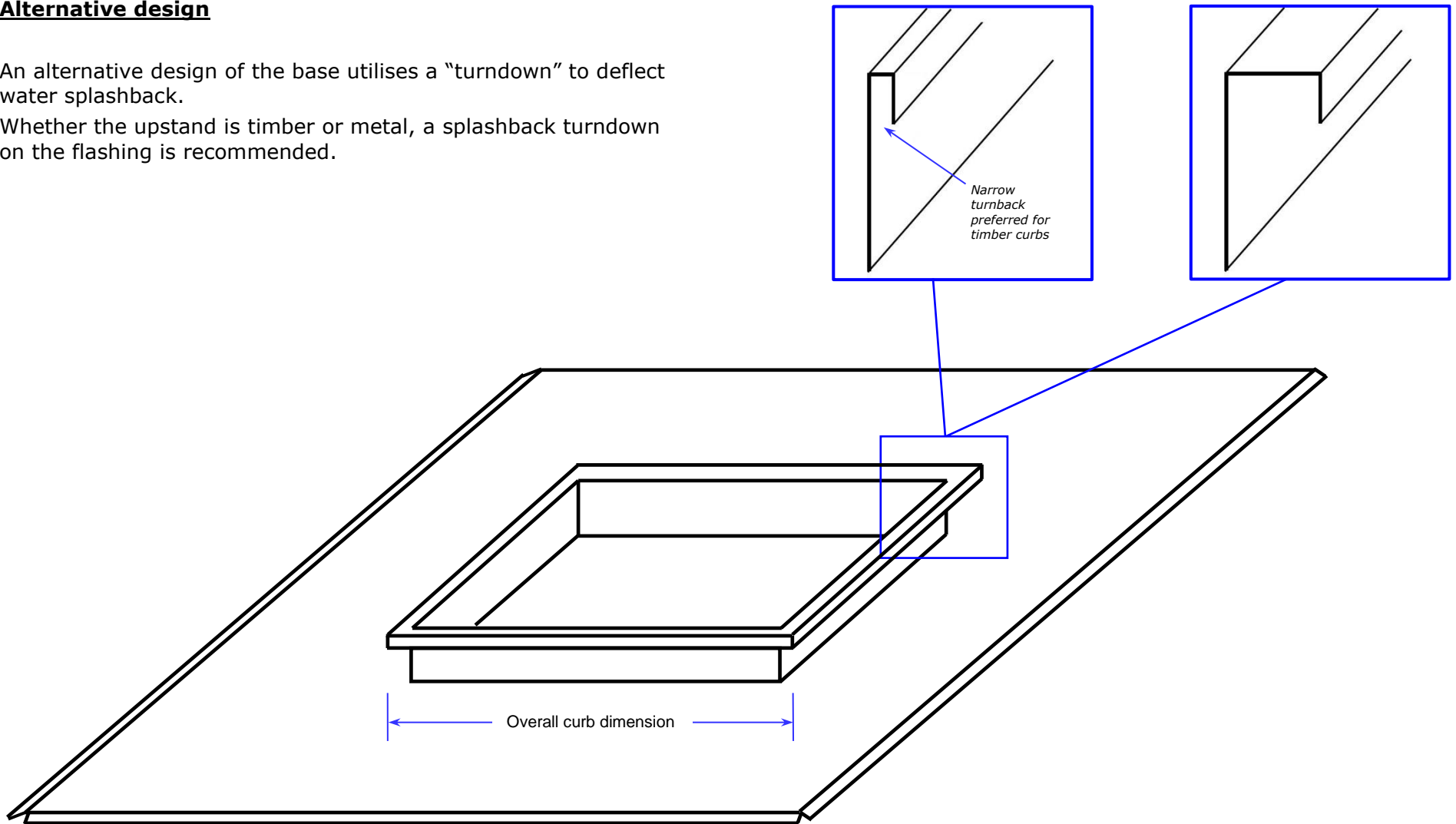

Bases are for illustration purposes ONLY. The 'apron' for each base must be made to suit the relevant roofing material. (as per pictures below)
 eg: for a tiled roof a flexible bottom apron is recommended. The sides and top of the base should sit under the tiles and the flexible apron should sit **above** the row of tiles immediately below the skylight.

Purpose-built flashing with top tray above roofing material



Purpose-built flashing with top tray under roofing material

Example of large, single opening for multiple skylights.

